

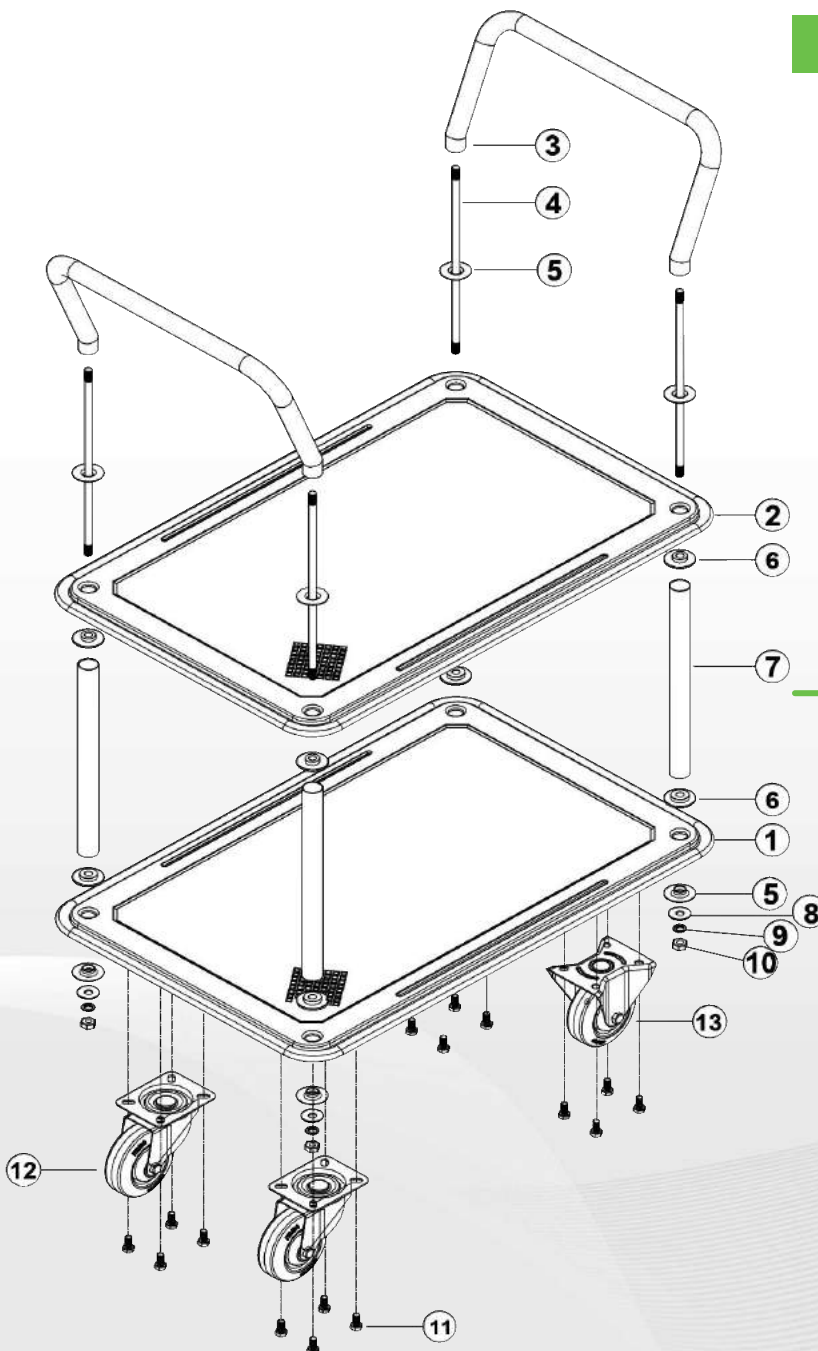

STURGO®

Assembly Diagram

Model: 12420010



No.	Description	Qty
1	Platform	1
2	Platform	1
3	Grip Handle	2
4	Screw Rod	4
5	Washer Support	8
6	Plastic Liner	8
7	Tube	4
8	Washer	4
9	Spring Washer	4
10	Nut	4
11	Bolt Flange	16
12	Swivel Wheel	2
13	Fixed Wheel	2

